

PW110N20YS

Perfect MOS4 N-MOSFET 200V, 9.1mΩ, 110A



重庆平伟实业股份有限公司

Features

- Uses PingWei advanced PerfectMOS4 technology
- Extremely low on-resistance $R_{DS(on)}$
- Excellent $Q_g \times R_{DS(on)}$ product(FOM)
- Excellent Low Ciss
- Qualified according to JEDEC criteria

Benefits

- High robustness and reliability
- Increases maximum current capability
- Low power loss, high power density
- Easy paralleling

Applications

- Synchronous Rectification for AC/DC Quick Charger
- Battery management
- UPS (Uninterruptible Power Supplies)



100% DVDS Tested
100% Avalanche Tested

Product Summary

V_{DS}	200V
$R_{DS(on)@10V}$ typ	9.1mΩ
I_D	110A

TO-247-3L

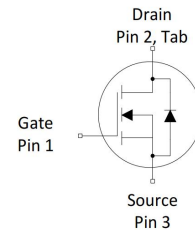
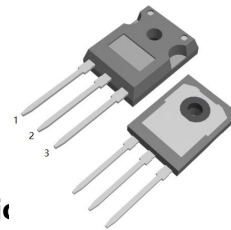

Package Marking and Ordering Information

Part #	Marking	Package	Packing	Reel Size	Tape Width	Qty
PW110N20YS	PW110N20YS	TO-247-3L	Tube	N/A	N/A	30pcs

Absolute Maximum Ratings

Parameter	Symbol	Value	Unit
Drain-source voltage	V_{DS}	200	V
Continuous drain current	I_D	110	A
$T_C = 25^\circ\text{C}$ (Silicon limit)		180	
$T_C = 25^\circ\text{C}$ (Package limit)		70	
$T_C = 100^\circ\text{C}$ (Silicon limit)		10	
$T_a = 25^\circ\text{C}$			
Pulsed drain current ($T_C = 25^\circ\text{C}$, $t_p = 100\mu\text{s}$)	$I_{D\ pulse}$	440	A
Avalanche energy, single pulse ($L=0.5\text{mH}$, $V_{ds}=100\text{V}$)	E_{AS}	342	mJ
Gate-Source voltage	V_{GS}	± 20	V
Power dissipation	P_{tot}	308	W
$T_C = 25^\circ\text{C}$		2.5	
$T_a = 25^\circ\text{C}$			
Operating junction and storage temperature	T_j, T_{stg}	-55...+150	$^\circ\text{C}$
Soldering temperature, wave soldering only allowed at leads (1.6mm from case for 10s)	T_{sold}	260	$^\circ\text{C}$



Thermal Resistance

Parameter	Symbol	Value			Unit	Test Condition
		min.	typ.	max.		
Thermal resistance, junction – case.	RthJC	-	0.26	0.41	°C/W	-
Thermal resistance, junction - ambient(min. footprint)	RthJA	-	-	50	°C/W	-

Electrical Characteristic (at Tj = 25 °C, unless otherwise specified)

Parameter	Symbol	Value			Unit	Test Condition
		min.	typ.	max.		

Static Characteristic

Drain-source breakdown voltage	BV_{DSS}	200	-	-	V	$V_{GS}=0V, I_D=250\mu A$
Gate threshold voltage	$V_{GS(th)}$	2.0	-	4.0	V	$V_{DS}=V_{GS}, I_D=250\mu A$
Zero gate voltage drain current	I_{DSS}	-	0.02	1	μA	$V_{DS}=200V, V_{GS}=0V$ $T_j=25^\circ C$ $T_j=150^\circ C$
Gate-source leakage current	I_{GSS}	-	± 10	± 100	nA	$V_{GS}=\pm 20V, V_{DS}=0V$
Drain-source on-state resistance	$R_{DS(on)}$	-	9.1	11.0	mΩ	$V_{GS}=10V, I_D=55A$
Transconductance	g_{fs}	-	74	-	S	$V_{DS}=5V, I_D=55A$

Dynamic Characteristic

Input Capacitance	C_{iss}	-	10380	-	pF	$V_{GS}=0V, V_{DS}=100V,$ $f=1MHz$
Output Capacitance	C_{oss}	-	364	-		
Reverse Transfer Capacitance	C_{rss}	-	64	-		
Gate Total Charge	Q_G	-	143	-	nC	$V_{DS}=100V, I_D=55A,$ $V_{GS}=10V$
Gate-Source charge	Q_{gs}	-	49	-		
Gate-Drain charge	Q_{gd}	-	30	-		
Turn-on delay time	$t_{d(on)}$	-	46	-	ns	$V_{GS}=10V, V_{DD}=100V,$ $R_{G_ext}=4.7\Omega, I_D=55A$
Rise time	t_r	-	21	-		
Turn-off delay time	$t_{d(off)}$	-	88	-		
Fall time	t_f	-	18	-		
Gate resistance	R_G	-	1	-	Ω	$V_{GS}=0V, V_{DS}=0V,$ $f=1MHz$



Body Diode Characteristic

Parameter	Symbol	Value			Unit	Test Condition
		min.	typ.	max.		
Body Diode Forward Voltage	V_{SD}	-	0.87	1.2	V	$V_{GS}=0V, I_{SD}=55A$
Body Diode Continuous Forward Current	I_S	-	-	110	A	TC = 25°C
Body Diode Pulsed Current	I_S pulse	-	-	440	A	TC = 25°C
Body Diode Reverse Recovery Time	t_{rr}	-	185	-	ns	$I_F=55A, dI/dt=100A/\mu s$
Body Diode Reverse Recovery Charge	Q_{rr}	-	469	-	nC	



Typical Performance Characteristics

Fig 1: Output Characteristics

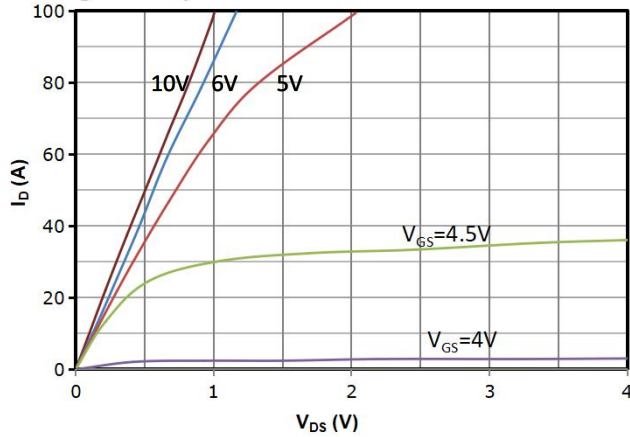

Fig 2: Transfer Characteristics

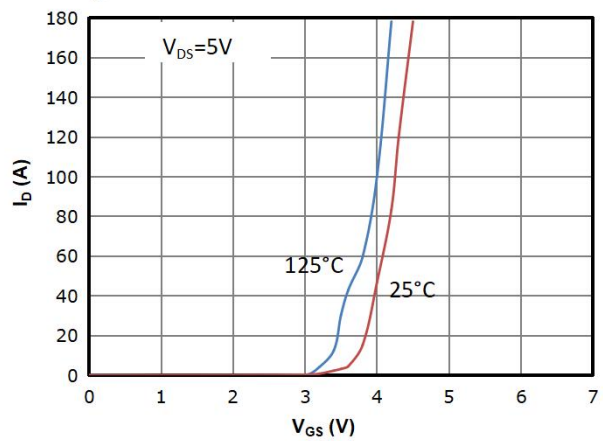

Fig 3: $R_{DS(on)}$ vs Drain Current and Gate Voltage

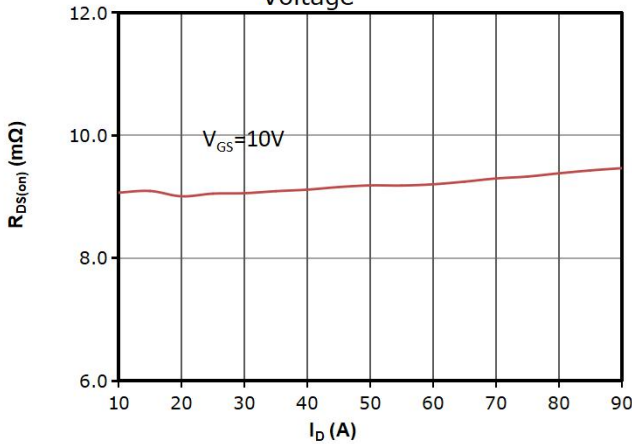

Fig 4: $R_{DS(on)}$ vs Gate Voltage

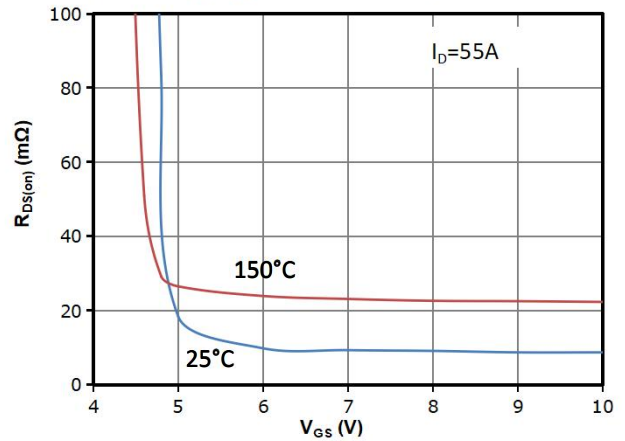

Fig 5: $R_{DS(on)}$ vs. Temperature

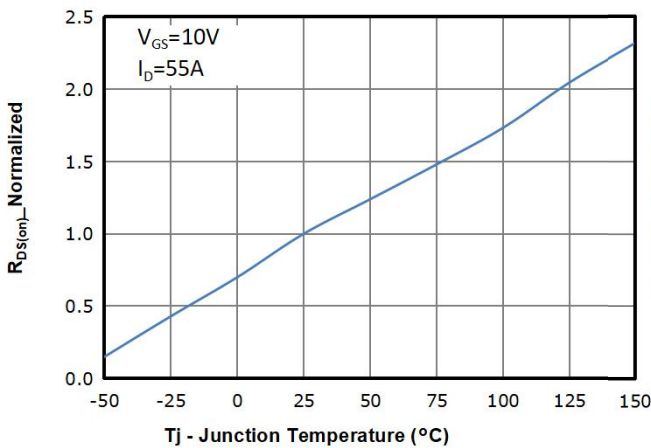

Fig 6: $V_{GS(th)}$ vs. Temperature

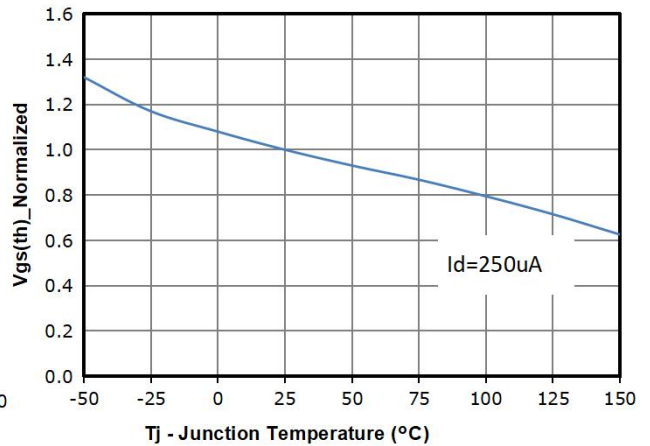



Fig 7: BVdss vs. Temperature

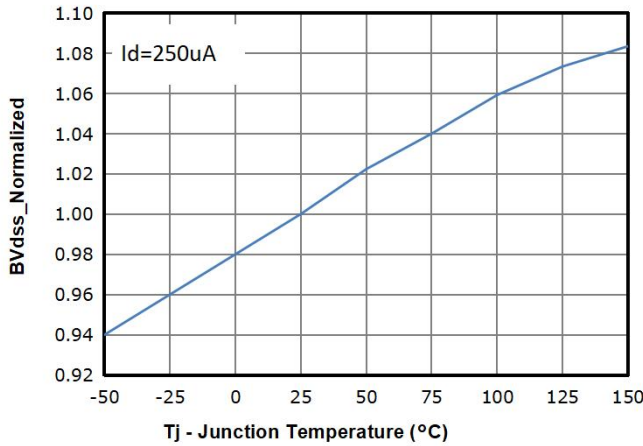

Fig 8: Capacitance Characteristics

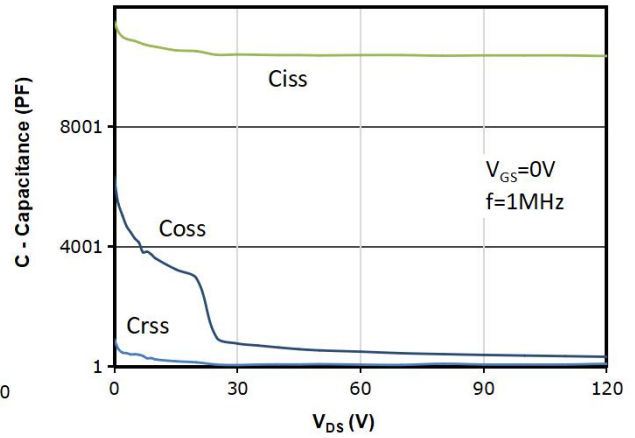

Fig 9: Gate Charge Characteristics

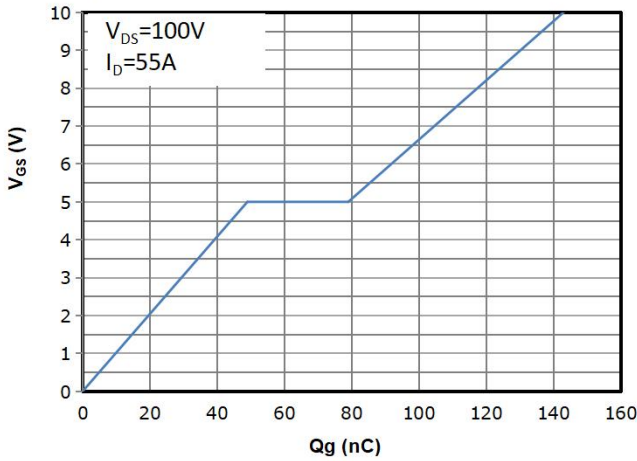

Fig 10: Body-diode Forward Characteristics

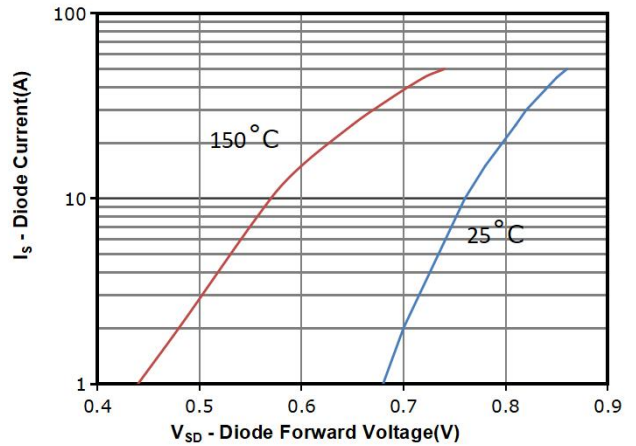

Fig 11: Power Dissipation

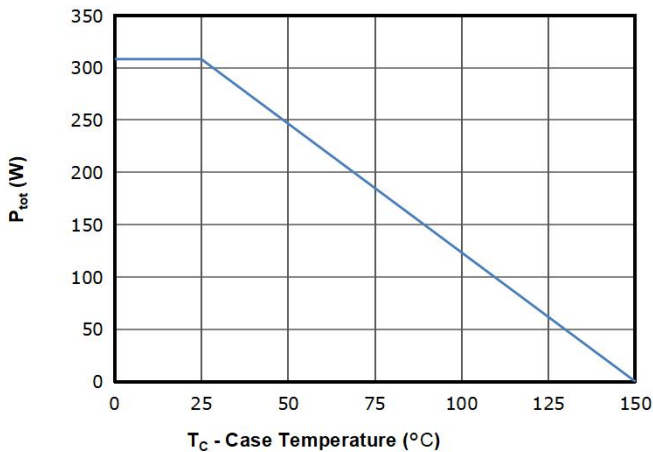

Fig 12: Drain Current Derating

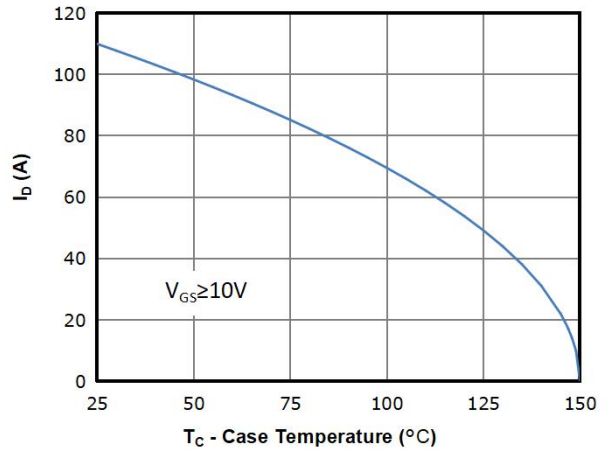



Fig 13: Safe Operating Area

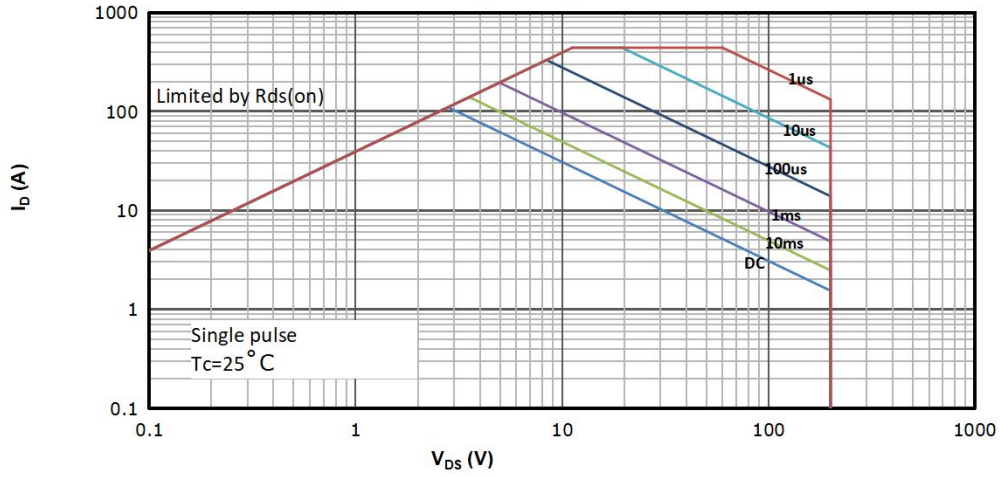
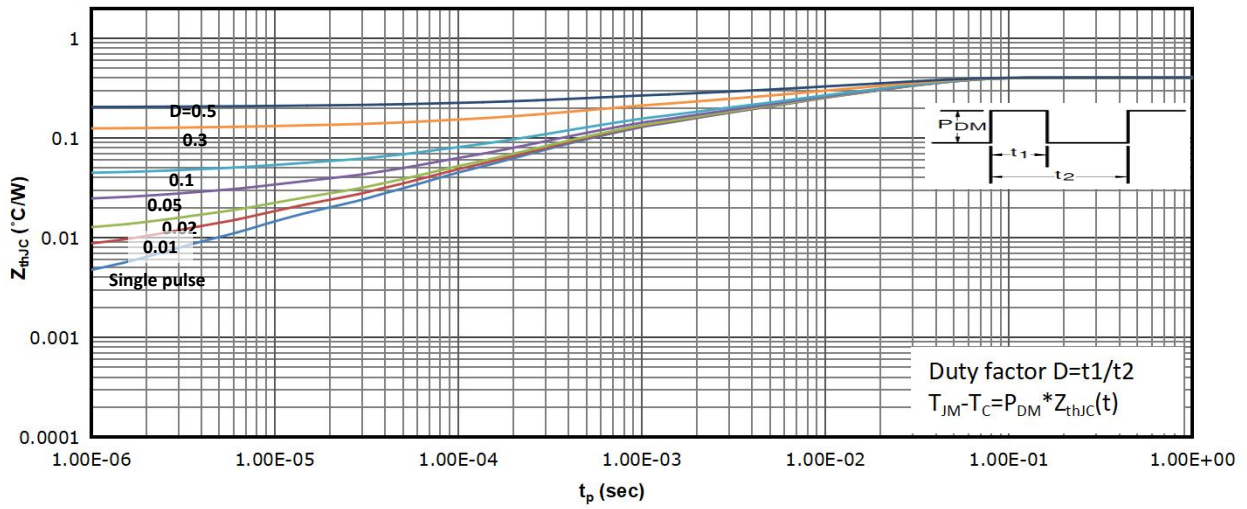
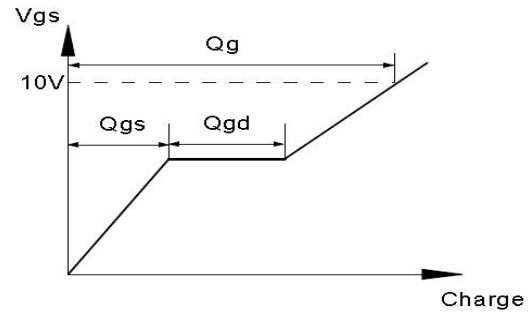
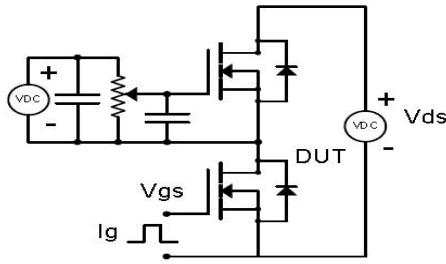

Fig 14: Max. Transient Thermal Impedance



Test Circuit & Waveform

Gate Charge Test Circuit & Waveform



Resistive Switching Test Circuit & Waveforms

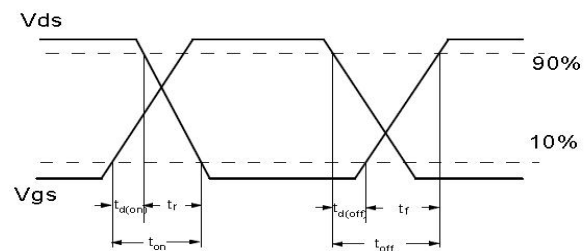
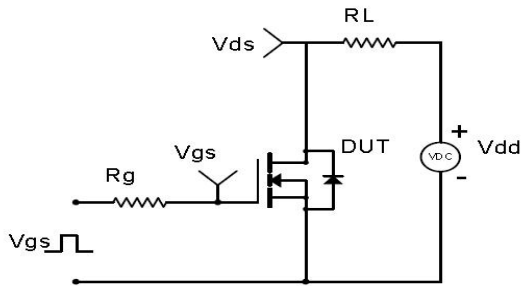

Unclamped Inductive Switching (UIS) Test Circuit & Waveforms

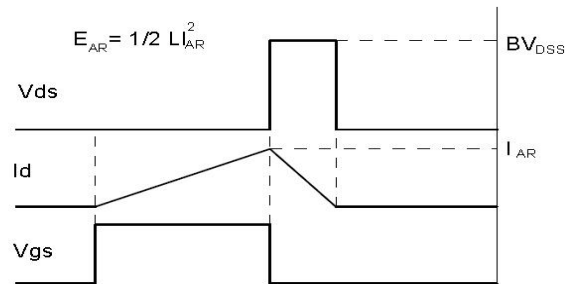

Diode Recovery Test Circuit & Waveforms

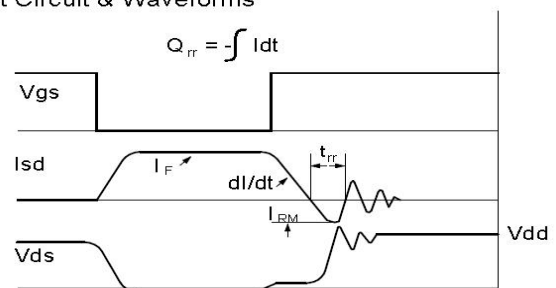
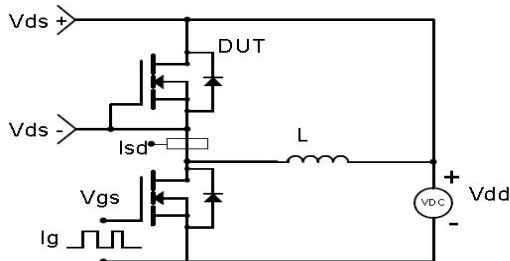

Package Outline: TO-247-3L

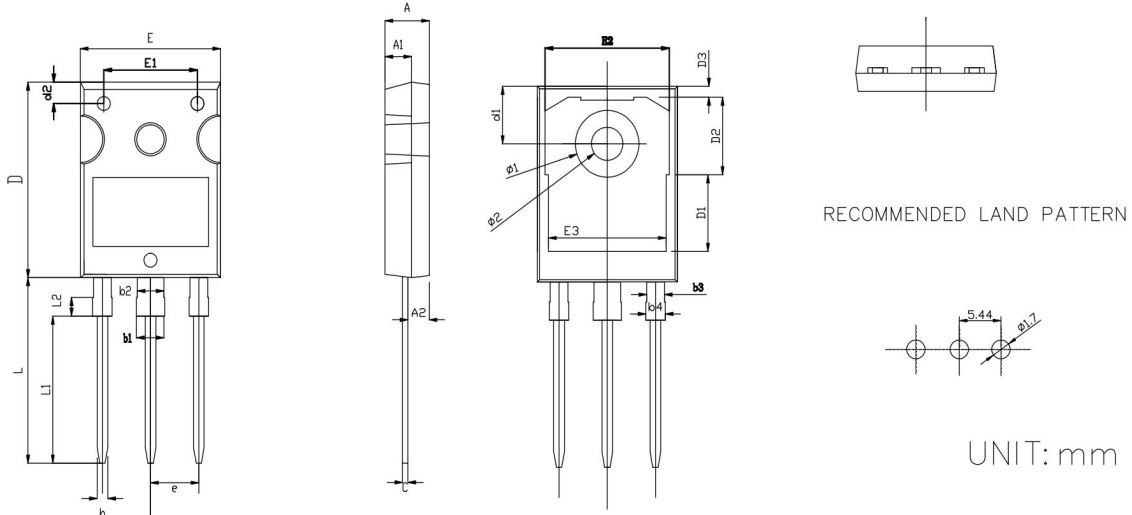

SYMBOL	MILLIMETERS		INCHES	
	MIN	MAX	MIN	MAX
A	4.80	5.20	0.189	0.205
A1	2.80	3.20	0.110	0.126
A2	2.26	2.56	0.089	0.101
b	1.10	1.30	0.043	0.051
b1	2.90	3.20	0.114	0.126
b2	2.90	3.10	0.114	0.122
b3	1.90	2.10	0.075	0.083
b4	2.00	2.20	0.079	0.087
c	0.50	0.70	0.020	0.028
D	20.80	21.20	0.819	0.835
D1	8.23		0.324	
D2	8.32		0.328	
D3	1.17		0.046	
d1	6.00	6.30	0.236	0.248
d2	2.20	2.40	0.087	0.094
E	15.60	16.00	0.614	0.630
E1	10.50		0.413	
E2	14.02		0.552	
E3	13.50		0.531	
e	5.34	5.54	0.210	0.218
L	19.72	20.12	0.776	0.792
L1	15.79		0.622	
L2	1.98		0.078	
φ1	7.10	7.30	0.280	0.287
φ2	3.50	3.70	0.138	0.146



Revision History

Revision	Date	Major changes
1.0	2023/3/7	Release of Formal Version.

Disclaimer

Any and all semiconductor products have certain probability to fail or malfunction, which may result in personal injury, death or property damage. Customer are solely responsible for providing adequate safe measures when design their systems.

Unless otherwise specified in the datasheet, the product is designed and qualified as a standard commercial product and is not intended for use in applications that require extraordinary levels of quality and reliability, such as automotive, aviation/aerospace and life-support devices or systems.

Buyer is responsible for its products and applications using PingWei products, including compliance with all laws, regulations and safety requirements or standards, regardless of any support or applications information provided by PingWei.

“Typical” parameters which may be provided in PingWei data sheets and/or specifications can and do vary in different applications and actual performance may vary over time. All operating parameters, including “Typicals” must be validated for each customer application by customer’s technical experts

ALL PRODUCT, PRODUCT SPECIFICATIONS AND DATA ARE SUBJECT TO CHANGE WITHOUT NOTICE TO IMPROVE RELIABILITY, FUNCTION OR DESIGN OR OTHERWISE